

ANCHORING DETAILS ARE FOR REFERENCE ONLY. FINAL SPECIFICATIONS AND DETAILS SHOULD BE APPROVED BY A LICENSED ENGINEER.

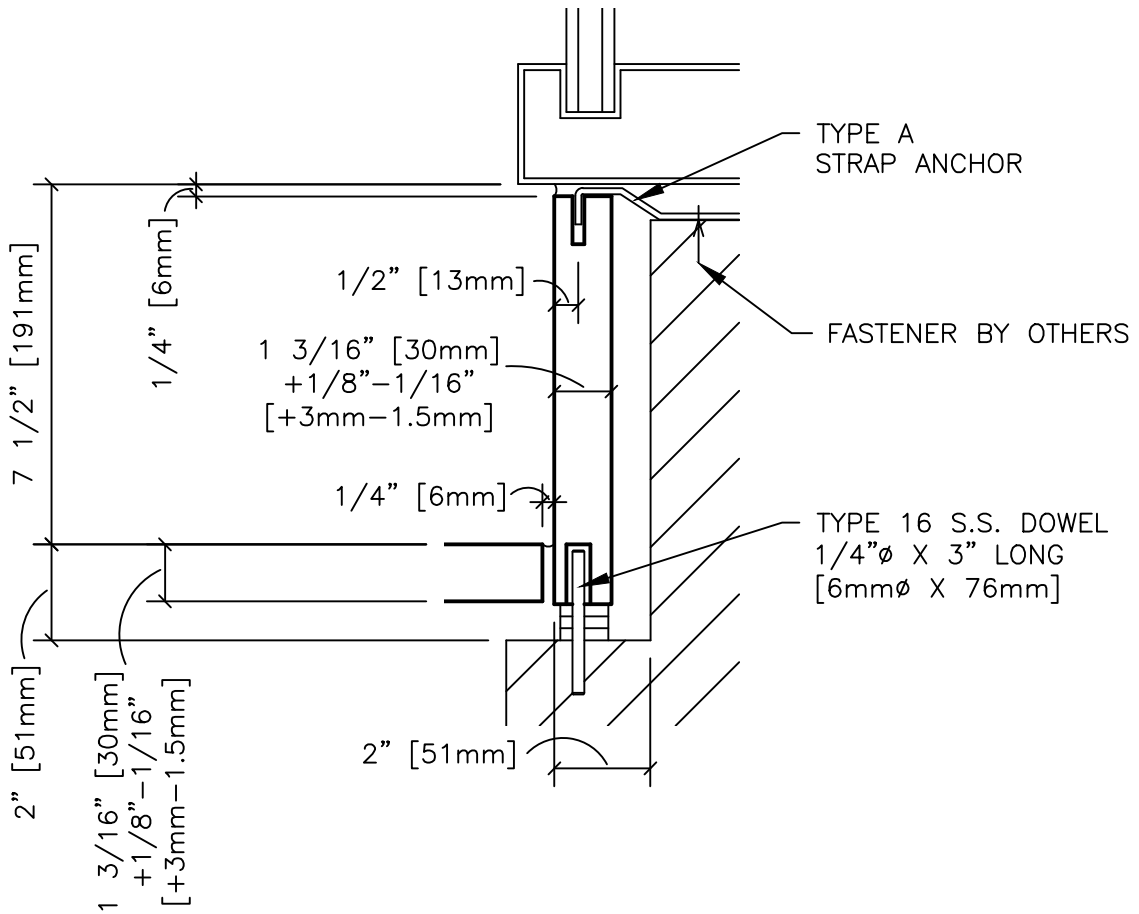

BASE DETAIL – ANCHOR AT TOP AND BOTTOM

DESCRIPTION:

BASE DETAIL  
ANCHOR AT TOP AND BOTTOM

SCALE:

3" = 1'-0"

DRAWN BY:

LB/KM

DATE:

4-6-2020



**COLDSPRING™**

17482 GRANITE WEST ROAD, COLD SPRING, MN 56320-4578  
PHONE (320) 685-3621, FAX (320) 685-5052  
WWW.COLDSPRINGUSA.COM