

MAKE SURE FAUCETS ARE COMFORTABLY AWAY FROM BACK SPLASH TO OPERATE.

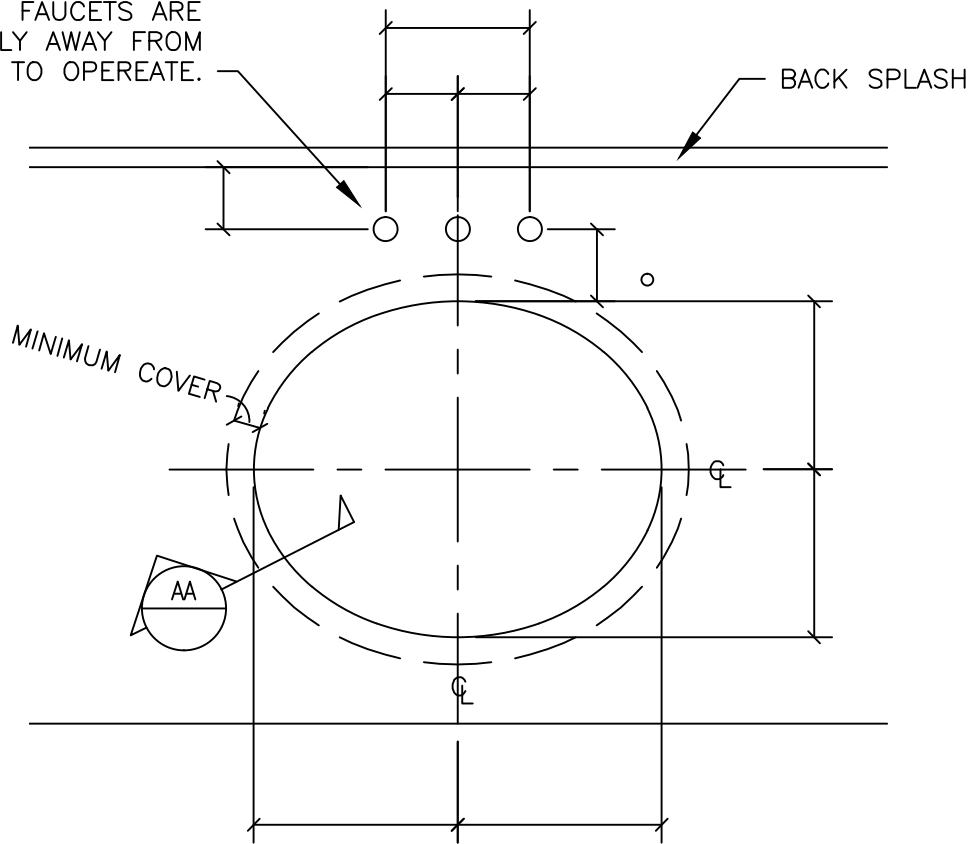

DROP IN SINK PLAN

CONSIDERATIONS:

FULL SIZE TEMPLATE FOR SINK BOWL CUT OUT
 -PURCHASER TO SUPPLY FULL SIZE TEMPLATE
 -IF UNAVAILABLE, PURCHASER TO SUPPLY ACTUAL SINK OR PROVIDE A MAKE AND MODEL NUMBER OF SINK TO BE USED. (VERIFY IF SINK IS TO BE RETURNED).

SINK CUT OUT LOCATION

-CENTERLINES WILL BECOME THE WORK POINTS FOR LOCATING FAUCET HOLES, SOAP DISPENSER, LOTION DISPENSER, AND ANCHORS FOR INSTALLING UNDER MOUNT SINKS.

FAUCET HOLES

-PURCHASER TO PROVIDE SIZE AND LOCATION OF FAUCET HOLES (CONSIDER SPACING BETWEEN HOLES)
 -REVIEW LOCATION OF FAUCETS WITH SINK BOWL, BACK SPLASH AND POSSIBLE STRUCTURAL SUPPORT BELOW.

SOAP DISPENSER AND LOTION DISPENSER

-CHECK IF SOAP/LOTION DISPENSER HOLES ARE REQUIRED.
 -IF SO, WHAT SIZE HOLE IS REQUIRED. WHERE IS HOLE LOCATED FROM CENTERLINES OF BOWL CUT OUT?

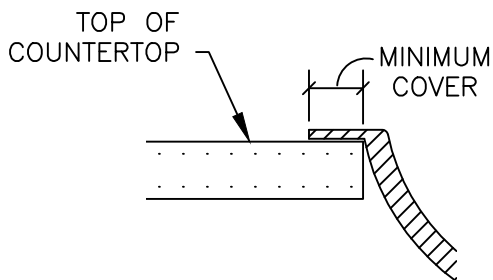

SECTION AA

DESCRIPTION:

VANITY DROP IN SINK

SCALE:

1 1/2" = 1'-0"

DRAWN BY:

LB/KM

DATE:

8-20-13



COLDSPRING™

17482 GRANITE WEST ROAD, COLD SPRING, MN 56320-4578
 PHONE (320) 685-3621, FAX (320) 685-5052
 WWW.COLDSPRINGUSA.COM