

ANCHORING DETAILS ARE FOR REFERENCE ONLY. FINAL SPECIFICATIONS AND DETAILS SHOULD BE APPROVED BY A LICENSED ENGINEER.

TYPE 31 TORQUE REQUIREMENTS:
 3/16" DIA. = 35 TO 40 IN. LBS.
 1/4" DIA. = 70 TO 80 IN. LBS.
 3/8" DIA. = 200 TO 220 IN. LBS
 1/2" DIA. = 400 IN. LBS

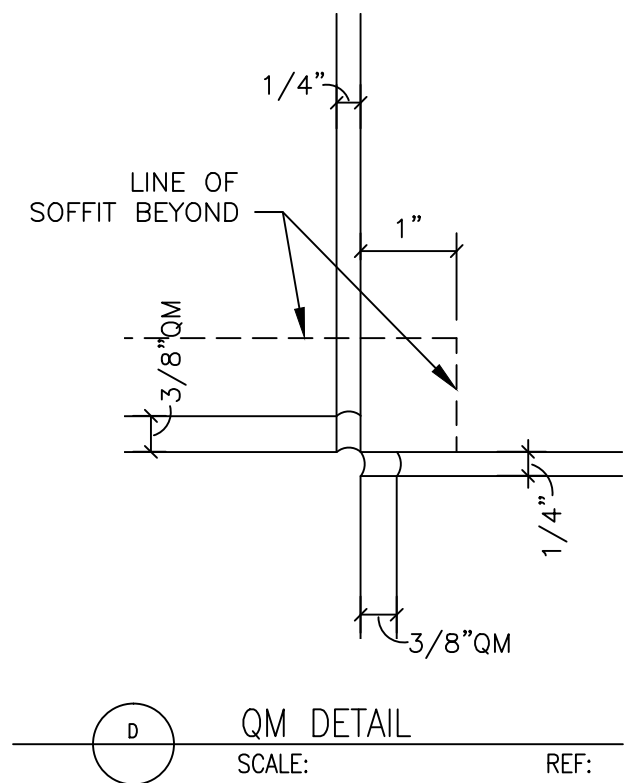

DESCRIPTION: REFLECTED SOFFIT DETAIL		
SCALE: 1" = 1'-0"	DRAWN BY: LB/KM	DATE: 9-18-13

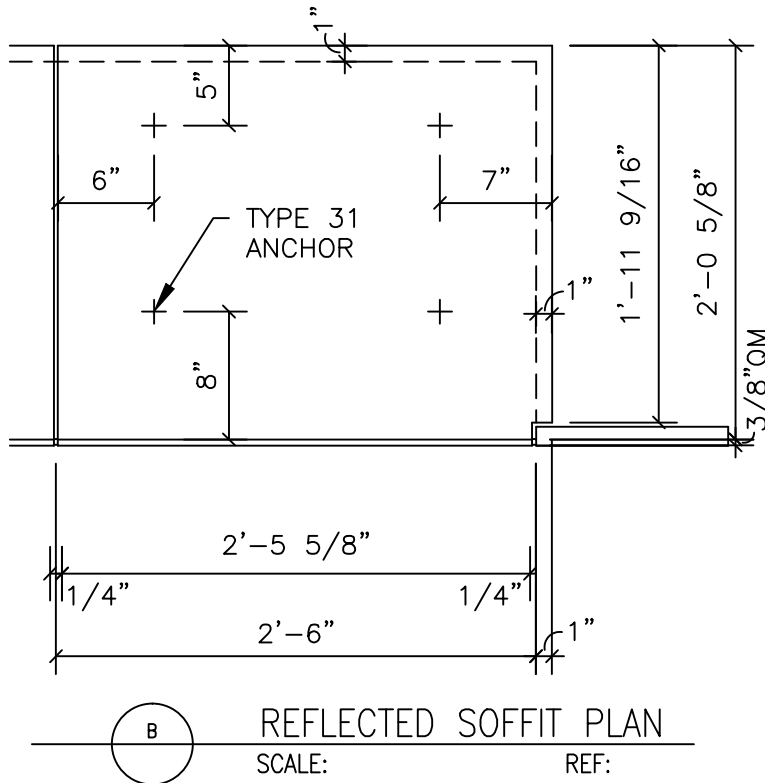
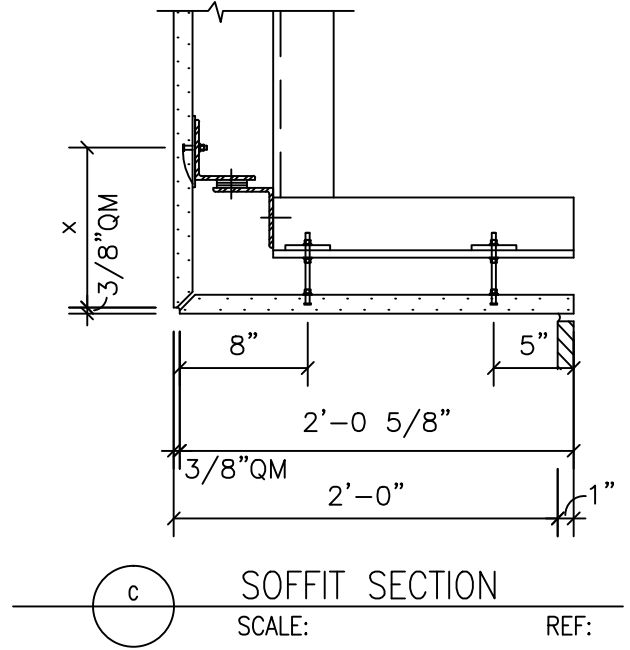
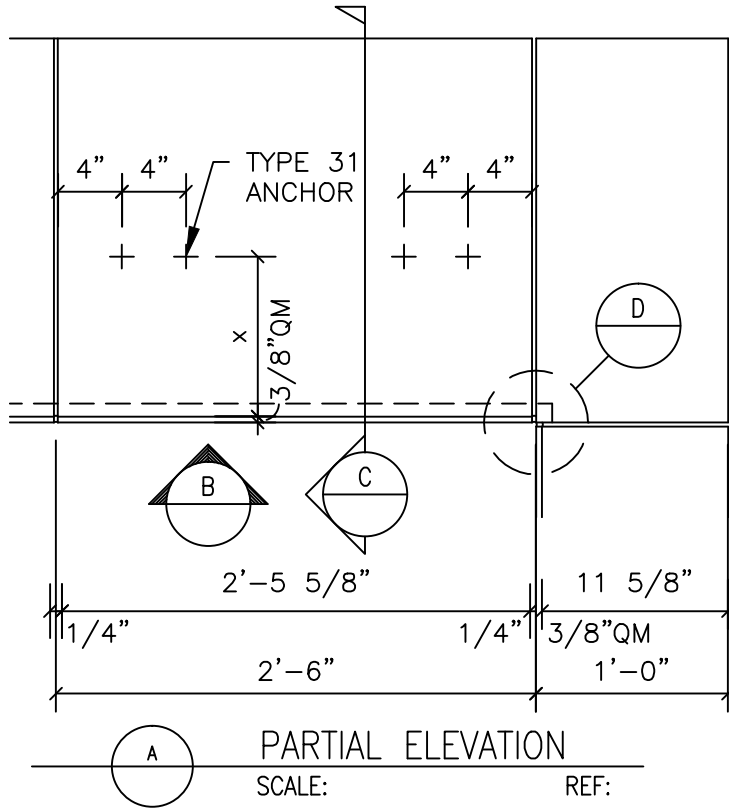

COLDSPRING™
 17482 GRANITE WEST ROAD, COLD SPRING, MN 56320-4578
 PHONE (320) 685-3621, FAX (320) 685-5052
 WWW.COLDSPRINGUSA.COM