

ANCHORING DETAILS ARE FOR REFERENCE ONLY. FINAL SPECIFICATIONS AND DETAILS SHOULD BE APPROVED BY A LICENSED ENGINEER.

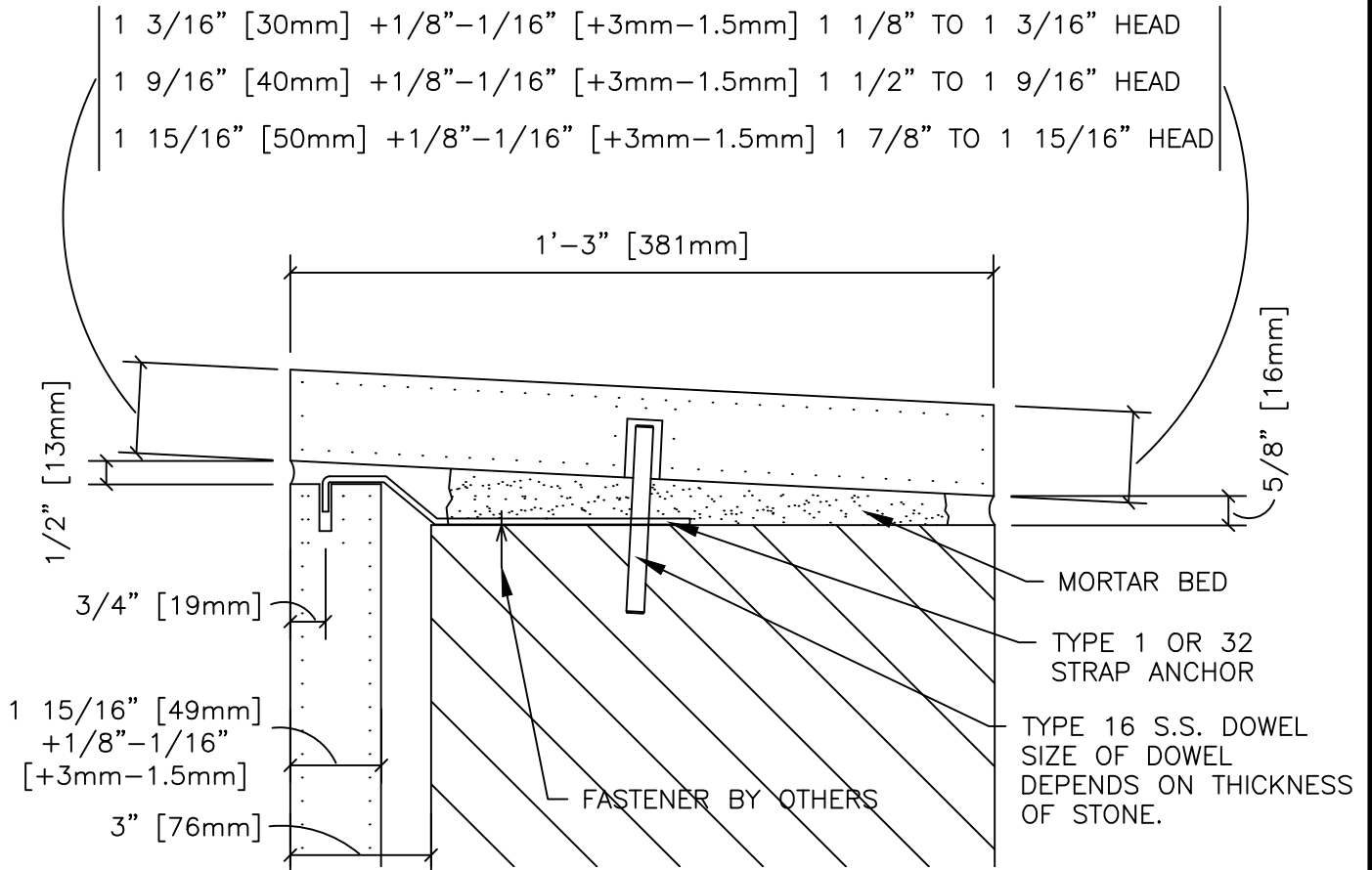

COPING WITH VERTICAL EDGES – 50mm OR LESS

DESCRIPTION:

COPING WITH VERTICAL EDGES
 50mm OR LESS

SCALE:

3" = 1'-0"

DRAWN BY:

LB/KM

DATE:

8-20-13



COLDSPRING™

17482 GRANITE WEST ROAD, COLD SPRING, MN 56320-4578
 PHONE (320) 685-3621, FAX (320) 685-5052
 WWW.COLDSPRINGUSA.COM